



**MATERION**



**BRUSH PERFORMANCE ALLOYS**

**MACHINING  
COPPER  
BERYLLIUM**

# MACHINING PERFORMANCE

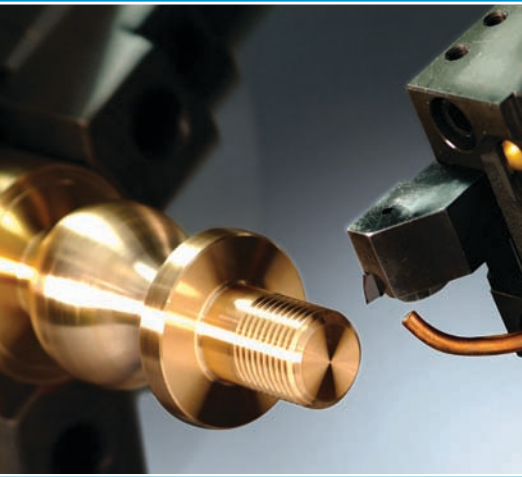
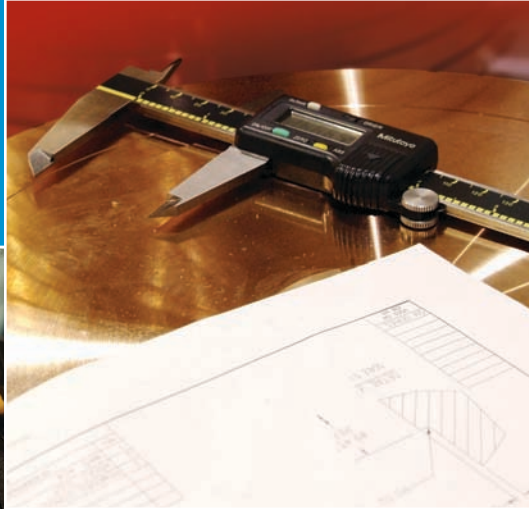

# TABLE OF CONTENTS

- List of Tables and Figures ..... 2
- Introduction ..... 3
- Copper Beryllium Alloys ..... 4
- Alloy Temper ..... 5
- Tool Materials and Coolants ..... 6
- Safe Handling of Copper Beryllium ..... 7
- Sawing Copper Beryllium ..... 8
- Turning Copper Beryllium ..... 9
- Drilling Copper Beryllium ..... 10
- Tapping Copper Beryllium ..... 11
- Reaming Copper Beryllium ..... 12
- Milling Copper Beryllium ..... 13
- Grinding Copper Beryllium ..... 14
- Electrical Discharge Machining Copper Beryllium ..... 15
- Appendix A ..... 16
- Appendix B ..... 18
- Scrap Generated from Machining ..... 20

## MACHINING COPPER BERYLLIUM



# LIST OF TABLES AND FIGURES

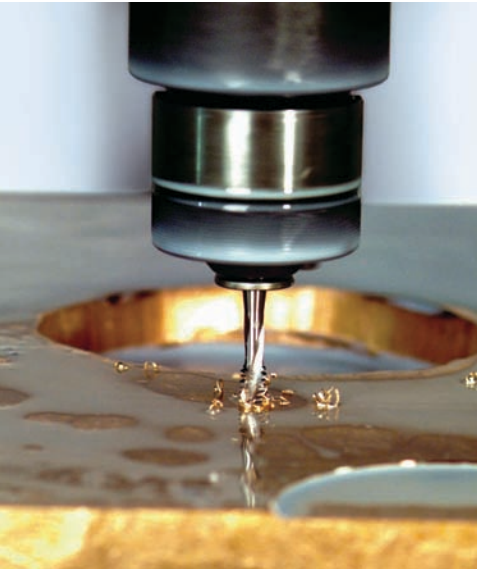
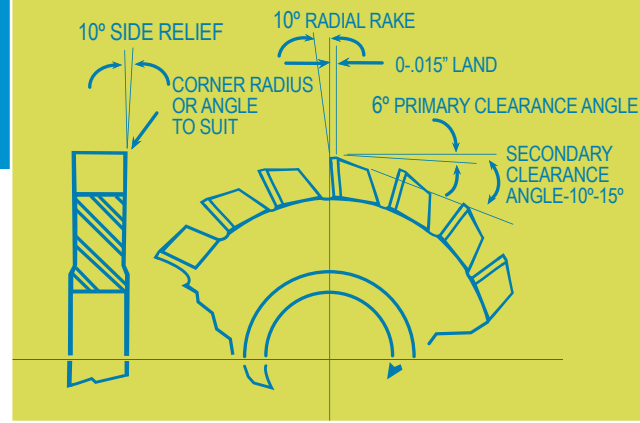

## TABLES

<b>Table 1:</b>	<b>Power Hack Sawing Parameters for High Speed Steel Blades</b>	8
<b>Table 2:</b>	<b>Power Band Sawing Parameters for High Speed Steel Blades</b>	8
<b>Table 3:</b>	<b>Turning Parameters for Carbide and High Speed Steel Tools</b>	9
<b>Table 4:</b>	<b>Drilling Parameters</b>	10
<b>Table 5:</b>	<b>Tapping Parameters and Tool Configurations</b>	11
<b>Table 6:</b>	<b>Reaming Parameters</b>	12
<b>Table 7:</b>	<b>Milling Parameters — Carbide —</b>	13
<b>Table 8:</b>	<b>Surface Grinding Wrought and Cast Copper Beryllium</b>	14
<b>Table 9:</b>	<b>Centerless Grinding Wrought and Cast Copper Beryllium</b>	14
<b>Table 10:</b>	<b>Example EDM Parameters for Copper Beryllium</b>	15
<b>Table 11:</b>	<b>Geometries for Ground Single Point Turning Tools</b>	16
<b>Table 12:</b>	<b>Single Point Tool Chip Breaker Geometry</b>	16
<b>Table 13:</b>	<b>Speed and Feed Adjustment Guide</b>	16
<b>Table 14:</b>	<b>Carbide Grade Adjustment Guide</b>	16
<b>Table 15:</b>	<b>Classification of Tool Materials</b>	17
<b>Table 16:</b>	<b>Cutting Speed Conversion</b>	17
<b>Table 17:</b>	<b>Typical Hardness of Copper Beryllium Rod, Bar, Plate, Tube and Wire</b>	18
<b>Table 18:</b>	<b>Typical Hardness of Copper Beryllium Castings</b>	19

## FIGURES

<b>Figure 1:</b>	<b>Drill Configuration</b>	10
<b>Figure 2:</b>	<b>Tap Configuration</b>	11
<b>Figure 3:</b>	<b>Reamer Configuration</b>	12
<b>Figure 4:</b>	<b>Milling Cutter Configuration</b>	13
<b>Figure 5:</b>	<b>Grinding Tool Configuration</b>	14
<b>Figure 6:</b>	<b>Single Point Turning Tool Geometry</b>	16
<b>Figure 7:</b>	<b>Single Point Turning Tool Chip Breaker Geometry</b>	16

Materion Brush Performance Alloys' are often the material of choice in applications spanning the automotive, aerospace, electronics, electromechanical, computer, telecommunications, oil & gas, appliance and medical industries. The popularity of these high reliability engineered materials stems from their combination of high conductivity and mechanical strength, excellent wear and corrosion resistance, nonmagnetic characteristics, high fatigue strength and hardness, and their ability to be worked in a soft condition and then hardened by a simple heat treatment.

The machining characteristics of copper beryllium alloys are a function of a given alloy's temper and form. This report furnishes the information most needed by shops performing the usual machining operations.

In doing so, it summarizes current machinability data as developed by Brush Performance Alloys and verified by a number of users with extensive experience in the machining of these materials.

It is important to note that machinability is not actually defined in this brochure and the various alloys and conditions are not rated according to any machinability index. After all, it is the number of machined parts per hour (determined partly by the machining speeds and feeds) which determines the economics of the machining operation. The machinability of a given material is ultimately a function of these factors, additional considerations such as part configuration, dimensional tolerances, the required surface finish and the skill of the machine tool operator.

The machining and tool recommendations are provided as a guide to the machinist working with copper beryllium alloys. These recommendations provide a starting point for each machining operation. Advances in machine tools, tooling materials, tool coatings and cutting fluids may require some changes in machining parameters. Machining methods also may need to be adjusted for individual part geometry.

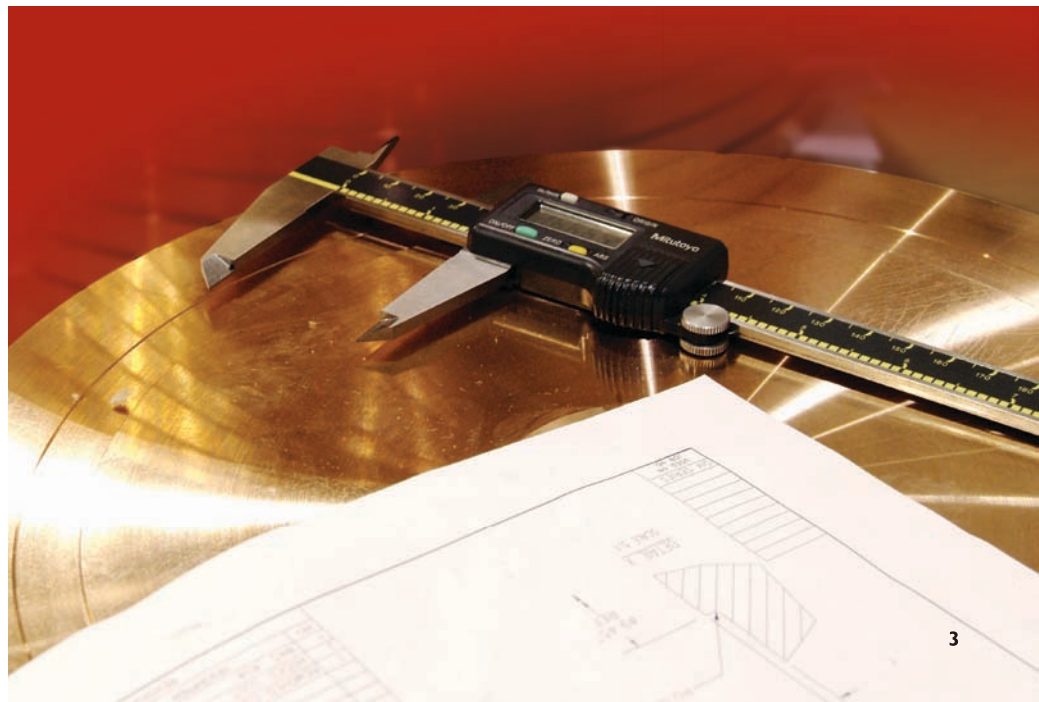

# COPPER BERYLLIUM ALLOYS



Brush Performance Alloys produces two classes of copper beryllium alloys: high strength and high conductivity. The high strength copper beryllium alloys, which have good electrical and thermal conductivity, are used in applications such as springs, electronic connectors, bearings, molds and corrosion resistant hardware. The high conductivity copper beryllium alloys, possessing moderate strength, are the materials of choice in current carrying springs, thermal control devices, welding electrodes and power connectors.

All copper beryllium alloys are readily machinable using conventional processes and the guidelines provided in this brochure.

Both the high strength and the high conductivity Brush Performance Alloys copper beryllium alloys are available in several wrought forms (e.g., strip, rod, wire, bar, tube and plate) as cast billet and as casting ingot.

A special lead-containing copper beryllium, free-machining Alloy M25, is used when the formation of small, discontinuous chips during

machining is desirable. Alloy M25 is available in wire and rod. Typically, it is turned on automated screw machines in the H or 1/2 H temper. The mechanical and physical properties of Alloy M25 are the same as those of unleaded Alloy 25. Similarly, the machining parameters for high strength copper beryllium Alloy M25 are the same as the other alloys in that family. Tool configurations for Alloy M25 may vary, as indicated in the tables of this book.

For further information on copper beryllium alloy forms, compositions, specifications, properties and manufacturing parameters, consult the Materion publications: Guide to High Performance Alloys, for wrought forms, and Copper Beryllium Casting and Master Alloys, for cast forms.

**Additional literature and assistance in alloy selection or problem solving also is available to you from [www.materion.com/brushalloys](http://www.materion.com/brushalloys) or Brush Performance Alloys Technical Service at 800.375.4205.**

## Brush Performance Alloys Designations (UNS Number)

High Strength		High Conductivity	
Wrought	Casting Ingot	Wrought	Casting Ingot
25 (C17200)	20C (C82500)	3 (C17510)	3C (C82200)
M25 (C17300)	21C (C82510)	10 (C17500)	10C (C82000)
165 (C17000)	165C (C82400)	174 (C17410)	
	245C (C82600)	Brush 60® (C17460)	
	275C (C82800)		

# ALLOY TEMPER



Copper beryllium alloys derive their high strength through heat treatment and, in the case of small cross section wrought forms, cold working. The amount of cold work and the type of heat treatment determine the alloy's properties. The combination of cold work and heat treatment define the alloy's temper. A brief definition of the temper designations is provided below.

Brush Performance Alloys supplies wrought products in either age hardenable or mill hardened tempers. The age hardenable tempers (e.g., A, ½ H and H) require heat treatment to produce the alloy's maximum strength and conductivity. The mill hardened tempers are heat treated before they leave the supplier. The specific machining operation and application requirements determine if the alloy is machined before or after heat treating.

The solution annealed temper (A) contains no cold work and is the softest temper. Adding cold work raises the alloy's hardness, but is limited to forms with cross sections typically less than 2 inches and is performed by the mill. Precipitation heat treatment further increases hardness of annealed and cold-worked tempers.

The heat treatment (age hardening) of the high strength, copper beryllium alloys is accompanied by a slight volume change. These alloys shrink about 0.5 volumetric percent. Where precise dimensional control is required, final machining should follow

heat treatment. Rough machining can be done before heat treating, but due to the excellent machinability of high strength copper beryllium alloys, it is recommended that the material be purchased and machined in the age hardened condition.\*

The high conductivity copper beryllium alloys are usually purchased in mill hardened tempers and are readily machinable because of their moderate hardness levels. There is no significant volume change during the heat treatment of the high conductivity alloys.

## Temper Designations

Brush Designation (ASTM DESIGNATION)	Description
<b>Wrought Products</b>	
<b>A (TB00)</b>	Solution annealed. Softest temper.
<b>½ H (TD02)</b>	Solution annealed and moderately cold-worked
<b>H (TD04)</b>	Solution annealed and fully cold-worked
<b>AT (TF00)<sup>2</sup></b>	Precipitation hardened A temper
<b>½ HT (TH02)<sup>2</sup></b>	Precipitation hardened ½ H temper
<b>HT (TH04)<sup>2</sup></b>	Precipitation hardened H temper. Hardest temper.
<b>Cast Products</b>	
<b>C (M01/M03)</b>	As cast (sand/investment). Slightly harder than annealed temper.
<b>CT (O11)<sup>2</sup></b>	Cast and precipitation hardened. Moderately hard.
<b>A (TB00)</b>	Solution annealed
<b>AT (TF00)<sup>2</sup></b>	Solution annealed and precipitation hardened. Hardest cast temper.

<sup>1</sup> Appendix B lists the hardness ranges for each of the copper beryllium tempers.

<sup>2</sup> The T designation indicates the alloy is heat treated after annealing or cold working. These are the hardest tempers.

\*Rod and bar smaller than 7/16 inch in cross section may not be available in age hardened, straight, long lengths.

# TOOL MATERIALS AND COOLANTS



All forms of copper beryllium are machined readily with either high speed steel or carbide tools. General purpose carbide grade C-2 is recommended where carbide tools are used, and M1, M2, T1 or T2 types of high speed tool steels are recommended when high speed steel tools are used. Coated tools provide the same advantage in machining copper beryllium as other alloys. Carbide tools can be used to a greater advantage if production runs are long and/or close dimensional tolerances must be maintained.

Because of the machining characteristics of all copper beryllium alloys, cutting tool life is excellent. Normally the tool life end point is a wear land of 0.060 inch for high speed steel tools and 0.015 to 0.030 inch for carbide tools. In many of the tests conducted to determine the proper speeds and feeds, this end point was never reached even though extremely high speeds and feeds were used.

The recommended speeds and feeds presented in this report for high speed steel tools are based on single point tool lives of sixty minutes of continuous cutting, resulting in a 0.060 inch wear land. The recommended speeds and feeds for carbide tools reflect thirty minutes of continuous cutting with a resulting 0.015 inch wear land. In actual shop operations where a number of tools are used alternately, time between grindings would be 3 to 4 times these values. In such instances, a tool life in excess of 6 to 8 hours would generally indicate speeds and feeds that are too low for optimum productivity.

Since wear generally is proportional to speed, it is not unusual for a 50 percent increase in speed to reduce tool life by 50 to 70 percent. Increasing feeds, while maintaining a fixed speed, may increase tool life up to a point but then reduce it in proportion to the feed rate. This is particularly evident at high cutting speeds.

The optimum combination of speed and feed is that which results in the greatest volume of metal removed (or greatest number of parts machined) for an allowable wear land, or for one tool change or grinding. Tool life in these terms increases greatly at moderate cutting speeds (300 ft/min) with feeds up to 0.020 in./rev. For higher speeds, tool life may reach a maximum and then decrease for feeds higher than 0.010 – 0.015 in./rev.

Naturally, the depth of cut enters into the rate of material removal. But, except for the softer alloys, this parameter is more dependent on factors like tool and work piece rigidity and machine horsepower than on the material being machined.

The foregoing discussion is based on the results of turning experiments but, in principle, it is applicable to other operations as well.

The use of coolants is recommended for all machining operations. Chemical emulsions, water-soluble oils and mineral/lard oil mixtures are the most desirable of the commonly used coolants. Unless sulfurized oils are immediately rinsed from machined parts, they may cause cosmetic staining.



# SAFE HANDLING OF COPPER BERYLLIUM

Copper beryllium in solid form and as contained in finished products presents no special health risks. Most manufacturing operations, conducted properly on well-maintained equipment, are capable of safely processing copper beryllium containing materials. However, like many industrial materials, copper beryllium may present a health risk if handled improperly. The inhalation of dusts, fumes or mists containing beryllium can cause a serious lung condition in some individuals. The degree of hazard varies, depending on the form of the product, how it is processed and handled, as well as the amount of beryllium in the product. You must read the product specific Material Safety Data Sheet (MSDS) for additional environmental, health and safety information before working with copper beryllium.

Copper beryllium is a ductile metal that machines easily, generally producing large chips and turnings. Processes that generate large particles are usually performed in an open shop environment with no special ventilation or housekeeping practices required. Machining processes that do generate small particles must be controlled with appropriate work practices and engineering controls. The table below provides a summary of those processes that typically present low inhalation concern and those that may present a likely inhalation hazard.

The operations itemized in the category “Low Inhalation Concern” are some common operations that produce machining chips which are large and non-respirable (>10 micrometers), are not expected to generate significant ultra-fine particulate, and/or are not expected to result in exposure in excess of the OSHA (Occupational Safety & Health Administration) PEL (Permissible Exposure Limit).

The machining operations in the category “Likely Inhalation Hazard” are some common operations that may produce respirable (<10 micrometer) particulate, may generate ultra-fine particulate, and/or may result in exposures in excess of the OSHA PEL. The particulate produced by these operations can be controlled by using a combination of engineering, work practice and administrative controls such as local exhaust ventilation (LEV), wet methods, substitution, enclosures and containment, and housekeeping.

In addition to these controls, personal protective equipment, such as respirators and protective clothing, and personal hygiene are used to minimize the potential for worker exposure to beryllium-containing particulate.

A qualified industrial hygienist or other qualified professional should be contacted to determine the appropriate manufacturing methods and controls that must be used.

## Low Inhalation Concern Machining Operations

Sawing (band or tooth blade)	Boring
Turning	Deburring (non-grinding)
Drilling	Hand Filing
Tapping	Stamping
Reaming	Slitting
Milling	

## Likely Inhalation Hazard Machining Operations

Grinding	Abrasive Sawing
Electrical Discharge Machining (EDM)	Abrasive Blasting
Polishing	Lapping
Sanding	Deburring (grinding)
Buffing	Coolant Management
Honing	Ventilation Maintenance

Additional information on safe handling and use of copper beryllium can be found at [www.materion.com/brushalloys](http://www.materion.com/brushalloys) or by contacting Materion Brush Performance Alloys Product Safety Hotline at 800.862.4118.

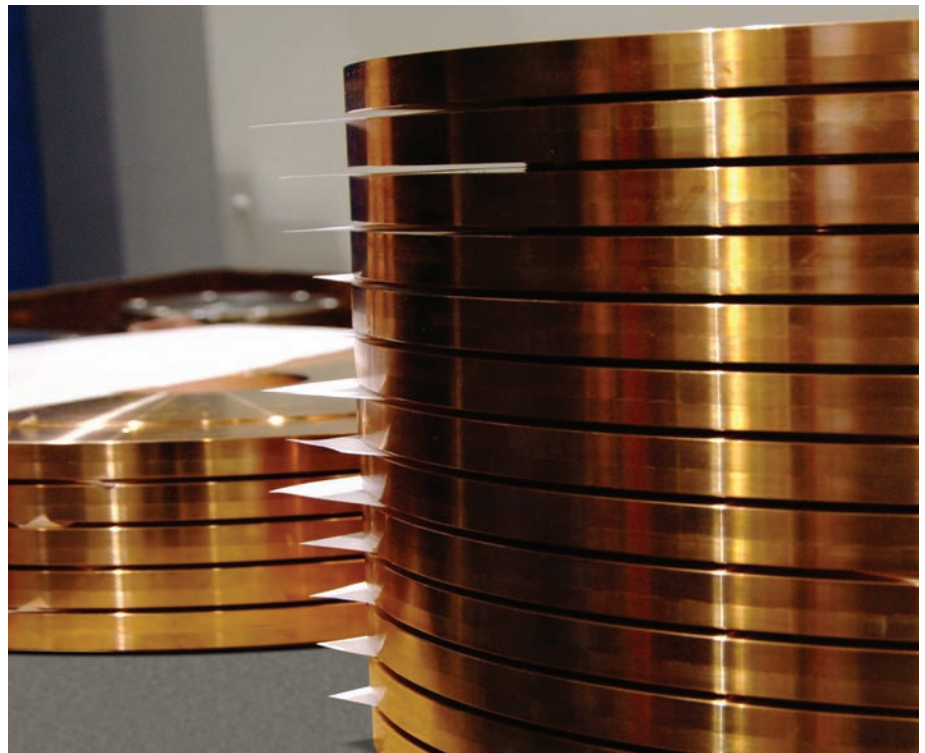

# SAWING COPPER BERYLLIUM



Copper beryllium can be sawed with high speed steel blades. However, when sawing larger sections, faster and more precise cuts can be made with carbide-tipped blades. If carbide is used, the recommended speed can be increased by 50%.

Work hardening of the material may result while sawing the annealed temper. Consequently, increased feed rates may be necessary for larger sections.

Parameters for power hack sawing and band sawing are provided in Tables 1 and 2 below.

**Table 1: Power Hack Sawing Parameters for High Speed Steel Blades**

Speeds and Feeds				Pitch(teeth/in.) - Material Thickness				
ALLOY	TEMPER	SPEED (stroke/min.)	FEED (in./stroke)	TOOL MATERIAL	<.25"	.25" - .75"	.75" - 2.0"	> 2.0"
25, M25, I65	A	90	0.007	HSS	10	6	6	4
	H,AT, HT	100	0.007	HSS	10	10	6	4
3,10	A	120	0.009	HSS	10	6	6	4
	H,AT,HT	140	0.009	HSS	10	10	6	4
3C, 275C, 245C, 20C, 21C, I65C	C	110	0.006	HSS	10	6	6	4

**Table 2: Power Band Sawing Parameters for High Speed Steel Blades**

Alloy	Temper	Material Thickness (inches)	Tooth Form <sup>1</sup>	Pitch (teeth/in.)	Band Speed (ft./min.)
25, M25, I65	A	<0.5	P	10-14	230
		.5- 1.0	P	6-8	195
		1.0 - 3.0	P	6	160
		>3.0	P,B	3-4	115
	H,AT,HT	<0.5	P	10-14	265
		.5 - 1.0	P	6-8	225
		1.0 - 3.0	P	6	180
		>3.0	P,B	3-4	135
3, 10	A	<0.5	P	10-14	320
		.5 - 1.0	P	8-10	285
		1.0 - 3.0	P	6	235
		>3.0	P,B	3-4	195
	H,AT,HT	<0.5	P	10-14	360
		.5 - 1.0	P	8-10	320
		1.0 - 3.0	P	6	270
		>3.0	P,B	3-4	220

<sup>1</sup> P - Precision, B - Butress

# TURNING COPPER BERYLLIUM

Metal removal by turning is probably the most common method employed by industry to produce finished shapes. Copper beryllium is easily machined in all types of turning equipment, from the small engine lathes to automated CNC machines.

All turning operations are performed satisfactorily with either high speed steel tools or carbide tools. Copper beryllium is easily sheared and cutting tools should be ground with generous positive rake angles. Zero or negative rake angles on the tools should be avoided when turning copper beryllium. Carbide inserts should have positive clearance (e.g., type C or P) and chip grooves (e.g., type M or T) except in cases of rough turning which may require a more sturdy insert (e.g. a CNMG insert). Recommended geometries for single point tools are given in Appendix A.

The side cutting edge angle should be varied to suit the configuration of the finished machined part, i.e. this angle will be 0° if the part requires a square shoulder; and should be approximately 15° if just a turning operation is to be performed. The side cutting edge angle of 15° will help prevent a rough-machined surface by directing the chips away from the already machined surface.

Recommended speeds and feeds for both high speed steel and carbide tooling are listed in **Table 3**. A carbide grade adjustment guide is provided in Appendix A. It is important to note that low feed rates (< 0.005 in./rev) will work harden copper beryllium, changing its temper, decreasing its machinability and causing excessive tool wear, although hardening in AT and HT tempers is minimal.

The high material removal rate that can be achieved when machining copper beryllium sometimes presents chip removal problems. The chips produced when machining Alloy M25 material or material in the AT or HT condition (heat treated) break up and are easily handled. Copper beryllium alloys in the A or H tempers (before heat treatment)

tend to form long, stringy, tough chips which may cause handling problems. This problem can be overcome by using chip breakers. Chip breakers curl and break the chips, making them easier to handle, and should be used whenever possible. The various chip breaker configurations are shown in Appendix A.

Although turning operations can be performed without cutting fluids, tool life and surface finish can be improved by using any of the coolants recommended earlier. Heavy-duty soluble emulsion and mineral/lard oil mixtures should be used for critical form tool applications. It is important to note that recommended cutting speeds should be reduced 25% when turning dry.

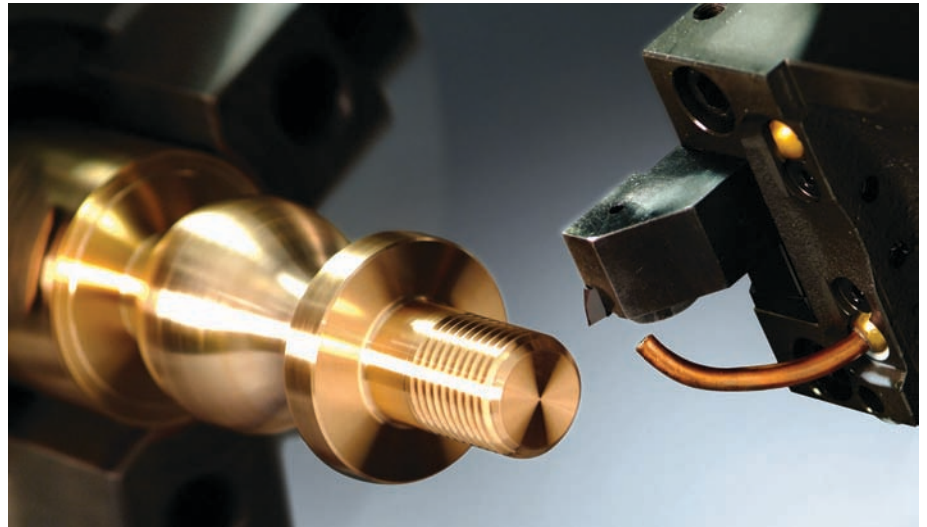

**Table 3: Turning Parameters for Carbide and High Speed Steel Tools**

Alloy	Temper	Speed (ft./min.) <sup>1</sup>	Feed (in./rev.)	Tool Material <sup>2</sup>
25, M25, I65	A	1500-1800	0.010-0.020	C-2
	H	1200-1500	0.010-0.020	C-2
	AT, HT	900-1200	0.010-0.020	C-2
3, I0	A, H, AT, HT	1500-1800	0.010-0.025	C-2
25, M25, I65	A	450-600	0.010-0.020	T-1
	H	250-400	0.010-0.020	T-1
	AT, HT	200-300	0.010-0.020	T-1
3, I0	A, H, AT, HT	600-700	0.010-0.025	M-2

<sup>1</sup> Reduce listed cutting speeds by 25% when turning dry.

<sup>2</sup> Classification of Tool Materials, Appendix A.

# DRILLING COPPER BERYLLIUM

Drilling operations are performed easily on all of the copper beryllium alloys. This applies regardless of material hardness, assuming good machining practices (such as tool rigidity, tool sharpness, ample cutting fluid and the proper speed and feed rates). Standard off-the-shelf high speed tool steel drills will perform satisfactorily for most drilling operations and material conditions. Coated tools provide the advantage of extended life.

When drilling operations are performed on castings which are in the solution heat treated and aged (AT) condition, the drills should be shortened as much as possible to increase rigidity. A special point called a brass point (Figure 1) should be ground on the drill. This effectively reduces the helix angle to about 5° and produces a much stronger cutting edge. Brass points also are recommended when drilling copper beryllium in the hardest tempers if chipping or breaking of the drill is a problem. Drills perform best when a constant speed and feed are applied. Copper beryllium will tend to work harden and become more difficult to drill if the drill point is allowed to rub or if the feed rate is too low.

Cutting fluid should be used for all drilling operations. The cutting fluid acts as a coolant, a lubricant and an aid in chip removal. An active oil or a chemical emulsion is recommended.

Recommended speeds, feeds and drill configuration are shown in Table 4 and Figure 1.

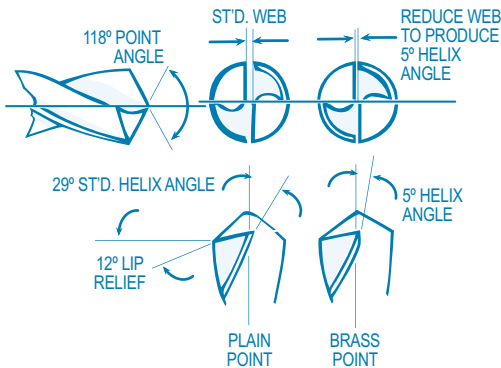

**Figure 1: Drill Configuration**

**Table 4: Drilling Parameters**

Alloy	Temper	Cutting Speed (ft./min.)	Feed Rate (in./rev.)	Point Type
25, M25, I65	A	200-350	0.002-0.009	PLAIN
	H	150-300	0.002-0.009	PLAIN
	AT, HT	100-300	0.002-0.009	PLAIN
3, I0	A, H	200-600	0.002-0.005	PLAIN
	AT, HT	125-500	0.002-0.005	PLAIN
275C, 245C, 20C, 21C, I65C	C, A	100-250	0.002-0.005	PLAIN
	CT, AT	75-100	0.002-0.005	BRASS
3C, I0C	C, A	100-500	0.002-0.005	PLAIN
	CT, AT	75-200	0.002-0.005	PLAIN

NOTE: Standard off the shelf HSS drills will perform satisfactorily and no alterations are necessary with the exception of the "brass point" which should be used when drilling these materials.

# TAPPING COPPER BERYLLIUM

Tapping is one of the most difficult metal removal tasks regardless of the work piece material. Aluminum is the easiest to tap, and the very high strength steels are the most difficult. Copper beryllium can be tapped successfully if care is taken in the selection of the tapping machine, cutting fluid, tap configuration, speeds and feeds. Since copper beryllium has much higher strength than other copper alloys, it should be classed with the tough, hard alloys rather than with softer brasses and bronzes. A machine of sufficient power should be used. The rigidity of the spindle and fixtures must ensure that the part and tap stay in alignment. Floating and torque sensitive tap holders can be used if alignment and/or tap breakage is encountered.

The ease with which copper beryllium alloys are tapped depends on the hardness of the material. Copper beryllium parts are usually tapped after heat treatment. However, the stress of tapping a small diameter hole may necessitate tapping the material before heat treating. The softer the copper beryllium, the easier it is tapped. Standard ground taps can be used for most tapping operations. Forming taps have been used for tapping annealed material where good thread finish is required. If forming taps are used, the tap manufacturer's recommended drill size

should be used for the tap drill hole. This will vary considerably from the tap drill size required for cutting type taps.

Spiral pointed or chip driver taps are recommended if the tap hole is through the part or if sufficient clearance is provided for chips.



Tap manufacturers have developed special grinds and flute configurations to simplify tapping tough materials.

Drastic changes in cutting speed, to improve tap performance, should be undertaken with caution. Tap life is sensitive to changes in cutting speed and the proper cutting speed must be used if maximum tool life is to be maintained.

The hook or rake angle ground on taps is standard for the various size taps, and varies little from one tap manufacturer to another (typically 7°). The cutting surface of a tap is along the length of the chamfer, in the case of the straight pointed tap, and along the angle of the spiral point (14°) and chamfer, in the case of the spiral pointed tap. The hook or radial rake angle will vary along the length of the cutting edge, from the end of the tap to the first full thread after the chamfer. Tap manufacturers have standardized tap geometry and no advantage is gained by altering these tried configurations. It is recommended that standard taps be used to tap copper beryllium alloys. It is important to note that coated taps will provide extended life.

The use of a cutting fluid is recommended when tapping all copper beryllium alloys. An active cutting oil, such as Cindol 3401 or equivalent, is suggested.

**Table 5: Tapping Parameters and Tool Configurations**

Alloy	Temper	Cutting Speed (ft./min.) <sup>1</sup>
25, M25, 165	A	50-100
	H	30-60
	AT, HT	15-25
3, 10	A	20-150
	H	10-60
	AT, HT	10-100
275C, 245C, 20C, 21C, 165C	C, A	20-50
	CT, AT	5-10
3C, 10C	C, A	10-75
	CT, AT	10-50

<sup>1</sup> Cutting speed is dependent largely on the rigidity of the tool; when tapping holes smaller than about 1/8" diameter, the low end of the cutting speed range should be used.

Recommended tapping speeds and tap configuration are shown in Table 5 and Figure 2.

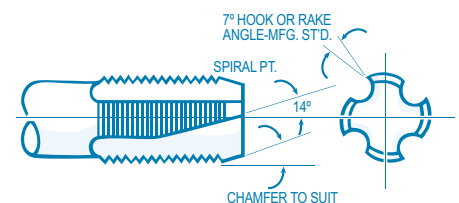

**Figure 2: Tap Configuration**

# REAMING COPPER BERYLLIUM

Reaming is a hole sizing operation and should only be included in the machining process when holes of close dimension or good finish are required. For best results, the reamer should be held in a floating holder so that it is free to follow the previously drilled or bored hole. The hole diameter should be sized so that the reamer has sufficient material into which it can cut. An excess of 0.005 to 0.010 inch on a side is recommended.

The tendency is to use a very slow feed when performing reaming operations. This is generally done to produce a smooth surface finish. It is important to note that, being a work hardenable material, copper beryllium will tend to harden at the surface that is in contact with the cutting edges of the reamer. This, in turn, makes it more difficult to cut. A feed rate between 0.002 and 0.010 in./rev. will minimize this hardening effect. Feed rates below 0.002 in./rev. can be used when the material is in the AT or HT temper since this material is already in the hardened state and the effect of cold working will be minimal.

To maximize the life of the reamer and the quality of the reamed holes produced, a cutting fluid should be used in copious amounts. In addition to cooling the reamer, an adequate supply of coolant will also facilitate chip removal.

Recommended speeds, feeds and reamer configuration are shown in Table 6 and Figure 3.

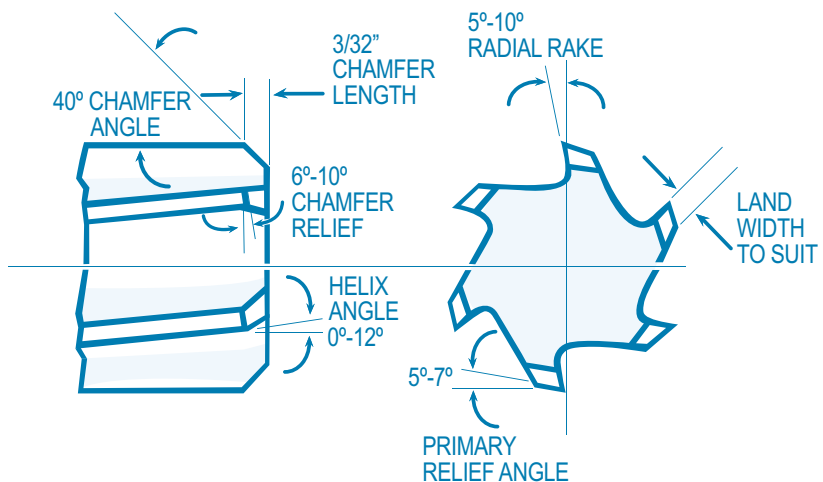

**Figure 3: Reamer Configuration**

**Table 6: Reaming Parameters**

Alloy	Temper	Speed (ft./min.) <sup>1</sup>	Feed (in./rev.) <sup>1</sup>
25, M25, I65	A, H	100-300	0.002-0.010
	AT, HT	50-200	0.002-0.010
3, 10	A, H	200-600	0.002-0.010
	AT, HT	125-500	0.002-0.010
275C, 245C, 20C, 21C, I65C	C, A	100-300	0.002-0.010
	CT, AT	50-200	0.002-0.010
3C, I0C	C, A	200-600	0.002-0.010
	CT, AT	125-500	0.002-0.010

<sup>1</sup> Speeds and feeds should be reduced when using reamers smaller than about 3/16" diameter.

# MILLING COPPER BERYLLIUM

Milling operations are performed with ease on all forms and tempers of copper beryllium. Carbide inserts and solid carbide tools are often employed to produce large production lots and machine tight tolerances. While satisfactory results can be achieved without the use of a cutting fluid, tool life, surface finish and chip removal will be improved if a cutting fluid is used.

Speeds, feeds and solid tool cutter configurations are shown in Table 7 and Figure 4.

Speed and feed should be reduced when using milling cutters of smaller

than approximately 3/16" diameter. All speeds and feeds are carbide tools. If high speed steel milling cutters are used, the recommended speeds should be decreased by a factor of 2 to 3; however, the feed rate should not be reduced.

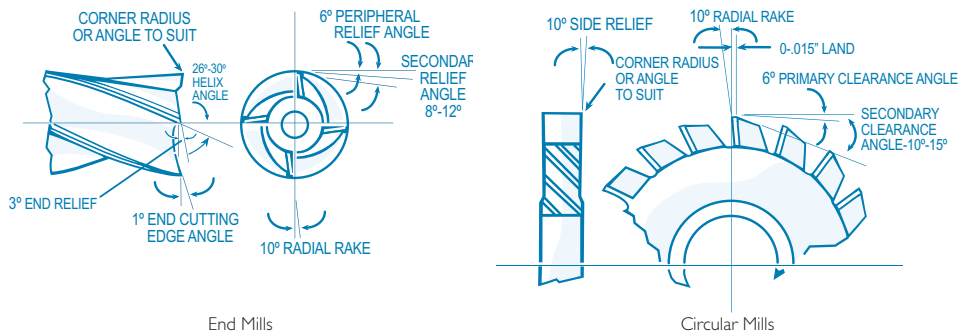
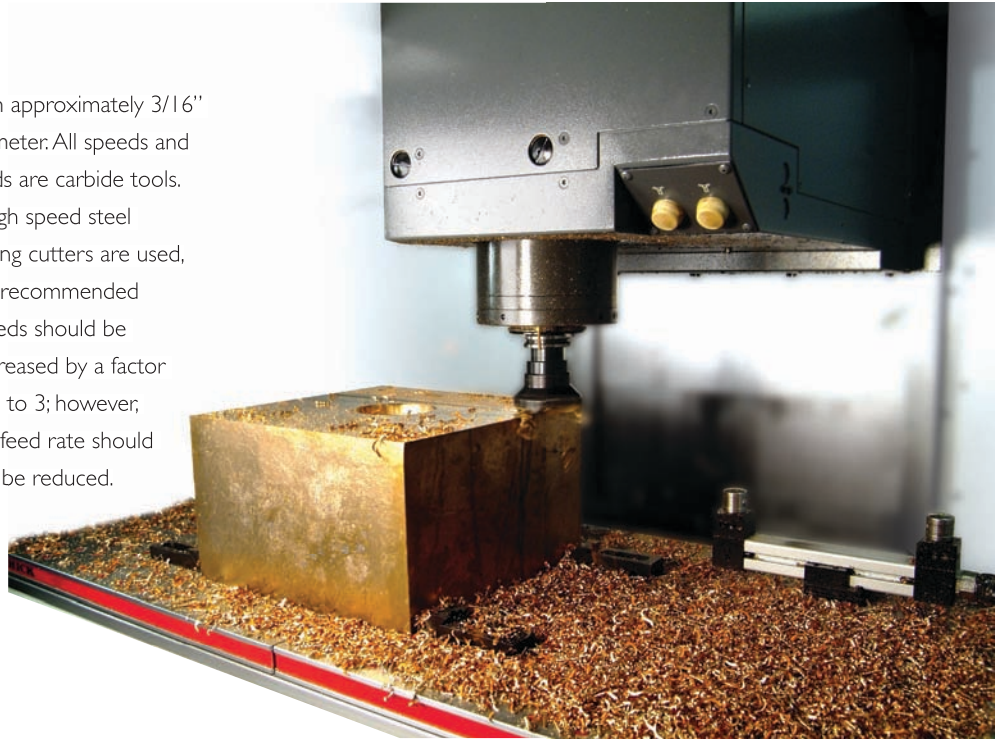

Figure 4: Milling Cutter Configuration

Table 7: Milling Parameters – Carbide

Alloy	Temper	Cutting Speed (ft./min.)	Feed (in./tooth)	Depth of Cut
25, M25, 165	A	500-625	0.001-0.003	0.060-0.200
	H	500-625	0.001-0.003	0.125-0.200
	AT, HT	375-500	0.001-0.003	0.060-0.125
3, 10	A	1000-2000	0.005-0.008	0.060-0.200
	H	1200-2000	0.006-0.010	0.125-0.200
	AT, HT	800-2000	0.005-0.008	0.060-0.125
275C, 245C, 20C, 21C, 165C	C, A	150-500	0.001-0.002	0.050-0.125
	CT, AT	100-200	0.001-0.002	0.050-0.125
3C, 10C	C, A	200-500	0.001-0.002	0.050-0.125
	CT, AT	150-400	0.001-0.002	0.050-0.125

# GRINDING COPPER BERYLLIUM

Copper beryllium alloys can undergo rough, precision, surface, cylindrical, centerless and internal grinding. However, it is important to note that their hardness classifies them with the tougher alloys.

Standard abrasives, such as aluminum oxide and silicon carbide, are acceptable for most operations. While harder abrasives are usually unnecessary, they can be used successfully. In either instance, both bonded wheel and coated belt configurations can be employed using either V (Vitrified) or B (Resinoid) bond type.

All grinding operations involving copper beryllium alloys must be controlled with appropriate engineering, work practice and administrative controls, such as local exhaust ventilation, personal protective equipment and housekeeping, to minimize the potential for exposure to airborne particulate. When these controls are ineffective, or are being developed, and potential exposures are above the occupational exposure limits, approved respirators must be used as specified by an industrial hygienist or other qualified professional.

The recommended tool configurations are shown in **Figure 5**. Speeds and feeds, for both surface (cylindrical) and centerless grinding, are shown in **Tables 8 and 9**. It is important to note that the copper beryllium alloys grind up to 100% faster than steel. Unlike brass and aluminum, these alloys pose no clogging problems with the use of high structure, porous belts and wheels.

Dry grinding produces particulate as a direct result of the operation. The particulate size is in proportion to the size of the particles contained in the grinding wheel. The products of these operations can also be entrapped and reground producing smaller particles. Effective particulate control is mandatory. Provide a ventilated enclosure at the point of origin and in the direct path of travel of the particulate (high-velocity exhaust ducts, vacuum hoses or hooded containment).

Wet grinding using a flood of cutting fluid produces the same particulate as described above, but the particles are entrapped which lowers the potential for exposure to airborne particulate. The cycling through of cutting fluid containing finely divided particulate in

suspension can result in the concentration building to a point where the particulate may become airborne during use. Prevent cutting fluid from splashing onto or coming in contact with floor areas, work surfaces, external structures, operators or operators' clothing. Utilize a filtering system to remove particulate from the cutting fluid. The cutting fluid used in these operations may dry, resulting in an inhalation hazard during or subsequent to the operation.

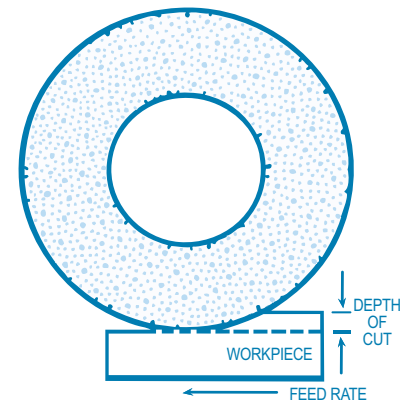

**Figure 5: Grinding Tool Configuration**

**Table 8: Surface Grinding Wrought and Cast Copper Beryllium**

Alloy : Temper	Rockwell Hardness	Wheel Speed (ft./min.)	Work Speed (ft./min.)	Infeed on Dia. (in./pass)	Traverse Wheel Width (per rev of work)	Wheel Identification <sup>1</sup> ISO & ANSI
25, M25, I65: A or H 3, I0: ALL	B20-100	5500 to 6500	70 to 100	ROUGH: 0.002 FINISH: <0.0005	1/3 to 1/6	C46JV
25, M25, I65: AT or HT	C34-45	5500 to 6500	70 to 100	ROUGH: 0.002 FINISH: <0.0005	1/3 to 1/6	A54LV

<sup>1</sup> Wheel recommendations are for wet grinding at 2 to 4 inch (50 to 100 mm) diameter work. For DRY grinding — use a softer grade wheel. For LARGER diameter work — use a softer and/or coarser grit wheel. For SMALLER diameter work — use a harder grade wheel. Wheel recommendations also apply to plunge grinding applications.

**Table 9: Centerless Grinding Wrought and Cast Copper Beryllium**

Alloy : Temper	Rockwell Hardness	Wheel Speed (ft./min.)	Work Speed (ft./min.)	Infeed on Dia. (in./pass)	Wheel Identification <sup>2</sup> ISO & ANSI
25, M25, I65: A or H 3, I0: ALL	B20-100	5500 to 6500	50 to 150	ROUGH: 0.001 FINISH: <0.0015	C46KV
25, M25, I65: AT or HT	C34-45	5500 to 6500	50 to 150	ROUGH: 0.002 FINISH: <.00015	A60LV

<sup>1</sup> As recommended starting conditions — use a regulating wheel angle with a positive inclination of 3° and a regulating wheel speed of 25 to 40 rpm.

<sup>2</sup> Wheel recommendations are for wet grinding 0.8 to 2 inch [20 to 50 mm] diameter work. For LARGER diameter work — use a softer grade and/or coarser grit wheel. For SMALLER diameter work — use a harder grade wheel.



# ELECTRICAL DISCHARGE MACHINING COPPER BERYLLIUM



Electrical Discharge Machining (EDM) is commonly used to produce copper beryllium molds and dies, to drill small, burr-free holes and to make prototype quantities of contacts for the aerospace and electronic markets. EDM is not dependent on the strength or hardness of the work piece and is used to machine copper beryllium in its age hardened state with no effect on the alloy's strength and no further heat treatment required.

Machining speeds are determined by the area of the work piece, the work piece material and the machining conditions. Since copper beryllium exhibits high electrical conductivity, machining rates are typically 20% lower than that of tool steels. When EDM'ing copper beryllium, it is suggested that the equipment parameters be set at the machine manufacturer's recommendations for copper and then adjusted accordingly to produce the desired results.

Compared to steel, copper beryllium must be EDM'd with low amperage and high voltage to produce acceptable results. The polarity of a solid state power supply can be either electrode positive or negative. Electrode negative polarity produces the highest metal removal rates and a rougher surface. Recently, it has become more common to use electrode positive polarity to increase the work-to-electrode

wear ratio, while providing a smoother surface. A dielectric fluid is required in all EDM operations. The dielectric acts as a spark conductor; a coolant, and a flushing medium that carries away swarf. For conventional EDM, the most common Dielectric fluids used are light petroleum-based oil for ram EDM and deionized water for wire EDM.

The surface texture of EDM'd copper beryllium resembles overlapping, small craters that exhibit no directionality. The surface roughness can range from 8 micro-inch Ra for finishing operations, to 500  $\mu$ -in. Ra for roughing operations. Recast and heat-affected layers occur on the order of 0.0001 to 0.005 inch and should be removed for fatigue-sensitive applications. Shot peening provides a smoother surface and improves fatigue life, but abrasive and electrochemical methods are required to remove the recast and underlying heat-affected layer. For most applications, removal of these layers is not necessary.

Travelling-wire (TW)-EDM utilizes the same principles as conventional EDM. For TW-EDM, brass and copper wire electrodes are most frequently used, with other possibilities being copper-tungsten, tungsten and molybdenum. Usually, deionized water is the dielectric fluid in TW-EDM. Wire diameters usually range

from 0.002 to 0.012 inch. Since the electrode is only used once, electrode wear is not a concern in most TW-EDM.

For TW-EDM, electrode (wire) negative polarity is used. The machining rates of copper beryllium are typically 20% lower than that of tool steels. TW-EDM is used for both roughing and finishing machining. Common practice is to rough cut to about 0.004 in. of finished dimensions, then follow with two or three finishing passes. A finishing cut takes about twice as long as a roughing cut, since lower spark energies and a lower metal removal rate must be used.

A TW-EDM surface exhibits a matte texture with typically 30 to 50  $\mu$ -in. Ra roughness.

Since beryllium has been detected in the atmosphere above the dielectric fluid during EDM of copper beryllium, ventilation equipment must be used. Care must be exercised when cleaning and maintaining EDM equipment that has been used to machine copper beryllium. Care must be exercised to assure that the particulate does not dry or otherwise become airborne. Do not clean equipment with air jets.

**EDM parameters taken from an actual conventional ram EDM trial are shown in Table 10.**

**Table 10: Example EDM Parameters for Copper Beryllium**

Voltage	220V
Current	50 A
Pulse on-time	32 $\mu$ sec.
Duty factor	50%
Electrode gap	300 $\mu$ m
Electrode polarity	positive
Electrode material	copper
Dielectric fluid	EDM 244TM 2
Material removal rate (25 AT or HT) <sup>1</sup>	0.36 in. <sup>3</sup> /hr.
Material removal rate (3 AT or HT) <sup>1</sup>	0.22 in. <sup>3</sup> /hr.
Tool wear ratio (25 AT or HT)	0.33
Tool wear ratio (3 AT or HT)	0.87

<sup>1</sup> The electrode was a 19mm dia rod.

<sup>2</sup> EDM 244TM is a trademark of Commonwealth Oil. The dielectric fluid was center flushed through the electrode.

# APPENDIX A

Tool geometries for ground single point tools are given in Table 11 and 12 and Figures 6 and 7 below.

**Table 11: Geometries for Ground Single Point Turning Tools**

Alloy	Temper	Back Rake	Side Rake	Side Cutting Edge Angle <sup>1</sup>	End Cutting Edge Angle	End and Side Relief	Nose Radius (in.)	Tool Material
25, M25, 165	A	0-10°	10°	0-15°	5°	5°	.032	C-2
	H	0-10°	10°	0-15°	5°	5°	.032	C-2
	AT, HT	0-10°	10°	0-15°	5°	5°	.032	C-2
3, 10	A, H, AT, HT	0°	5°	0-15°	15°	5°	.030	C-2
25, M25, 165	A	0-20°	20°	0-15°	5°	5°	.032	T-1
	H	0-10°	10°	0-15°	5°	5°	.032	T-1
	AT, HT	0-10°	10°	0-15°	5°	5°	.032	T-1
3, 10	A, H, AT, HT	0°	10°	0-15°	5°	5°	.030	M-2

<sup>1</sup> The side cutting angle should be varied to suit the configuration of the finished part, i.e. this angle will be 0° if the part requires a square shoulder; and should be approximately 15° if just a turning operation is to be performed. The side cutting angle of 15° will help prevent a rough machined surface by directing chips away from the already machined surface.

**Table 12: Single Point Tool Chip Breaker Geometry**

Depth of Cut	Feed (in./rev.)			
	.008 - .012	.013 - .017	.018 - .027	.028 - .035
1/64 to 3/64	1/16	5/64	7/64	1/8
3/64 to 1/4	3/32	1/8	5/32	3/16
1/4 to 1/2	1/8	5/32	3/16	7/32
1/2 to 3/4	5/32	3/16	3/16	3/16
Over 3/4	3/16	3/16	3/16	3/16

The recommended speeds and feeds for machining copper beryllium are for average conditions. The charts below will aid in making speed and feed adjustments if conditions warrant.

**Table 13: Speed and Feed Adjustment Guide**

Desired Effect	Action
Reduce Cratering	Increase Speed and/or Reduce Feed
Reduce Edge Build-Up	Increase Speed
Reduce Edge Wear	Reduce Speed and/or Increase Feed

**Table 14: Carbide Grade Adjustment Guide**

Chipping or Breaking		Excessive Wear	
Using Grade	Change to Grade	Using Grade	Change to Grade
C-3 or C-4	C-2	C-1	C-2
C-2	C-1	C-2	C-3 or C-4

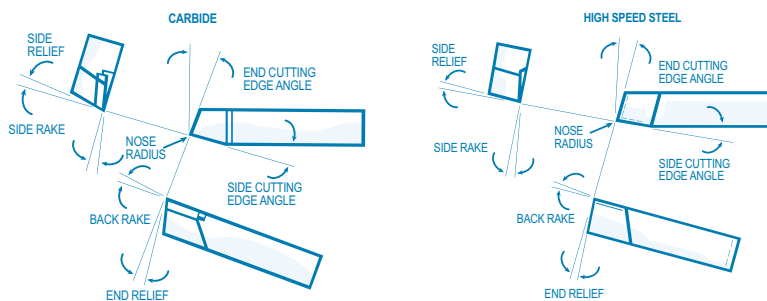

**Figure 6: Single Point Turning Tool Geometry**

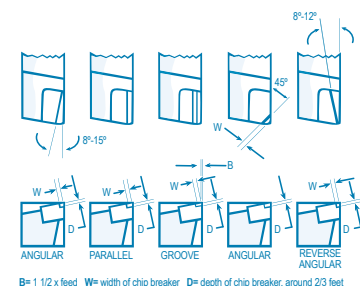

**Figure 7: Single Point Turning Tool Chip Breaker Geometry**

**Table 15: Classification of Tool Materials**

Type	Application
<b>Carbide Grades</b>	
C-1	Roughing
C-2	General Purpose
C-3	Finishing
C-4	Precision Finishing
<b>High Speed Steel (Molybdenum Types)</b>	
M1 & M2	General Purpose
M3 CLASSES 1 & 2	Fine Edge Tools
M4	Abrasion Resistant Tools
M6	Heavy Cuts Abrasion Resistant Tools
M7	FINE EDGE Abrasion Resistant Tools
M10	General Purpose High Strength Tools
M15 THRU M441	Heavy Cuts Abrasion Resistant Tools
<b>High Speed Steel (Tungsten Types)</b>	
T1	General Purpose
T2	General Purpose High Strength Tools
T4	Heavy Cuts
T5	Heavy Cuts Abrasion Resistant Tools
T6	Heavy Cuts – Hard Material
T7	Planer Tools
T8	General Purpose – Hard Materials
T9 & T15	Extremely Abrasion Resistant Tools

<sup>1</sup> M15, M30, M33, M34, M35, M36, M41, M42, M43, M44

**Table 16: Cutting Speed Conversion**

**Speed (ft./min.)**

Dia. of Work (in.)	Speed (ft./min.)																	
	50	100	150	200	250	300	400	500	600	700	800	900	1000	1200	1400	1600	1800	2000
<b>Required Revolutions PER Minute of Work or Cutter</b>																		
1/8	1528	3056	4584	6112	7639	9167	12223	15279	18335	21390	24446	27502	30558	36669	42781	48892	55004	61115
3/16	1019	2037	3056	4074	5093	6112	8149	10186	12223	14260	16297	18335	20372	24446	28521	32595	36669	40744
1/4	764	1528	2292	3056	3820	4584	6112	7639	9167	10695	12223	13751	15279	18335	21390	24446	27502	30558
5/16	611	1222	1833	2445	3056	3667	4889	6112	7334	8556	9778	11001	12223	14668	17112	19557	22002	24446
3/8	509	1019	1528	2037	2546	3056	4074	5093	6112	7130	8149	9167	10186	12223	14260	16297	18335	20372
7/16	437	873	1310	1746	2183	2619	3492	4365	5238	6112	6985	7858	8731	10477	12223	13969	15715	17462
1/2	382	764	1146	1528	1910	2292	3056	3820	4584	5348	6112	6875	7639	9167	10695	12223	13751	15279
5/8	306	611	917	1222	1528	1833	2445	3056	3667	4278	4889	5500	6112	7334	8556	9778	11001	12223
3/4	255	509	764	1019	1273	1528	2037	2546	3056	3565	4074	4584	5093	6112	7130	8149	9167	10186
7/8	218	437	655	873	1091	1310	1746	2183	2619	3056	3492	3929	4365	5238	6112	6985	7858	8731
1	191	382	573	764	955	1146	1528	1910	2292	2674	3056	3438	3820	4584	5348	6112	6875	7639
1 1/8	170	340	509	679	849	1019	1358	1698	2037	2377	2716	3056	3395	4074	4753	5432	6112	6791
1 1/4	153	306	458	611	764	917	1222	1528	1833	2139	2445	2750	3056	3667	4278	4889	5500	6112
1 3/8	139	278	417	556	694	833	1111	1389	1667	1945	2222	2500	2778	3334	3889	4445	5000	5556
1 1/2	127	255	382	509	637	764	1019	1273	1528	1783	2037	2292	2546	3056	3565	4074	4584	5093
1 5/8	118	235	353	470	588	705	940	1175	1410	1645	1880	2116	2351	2821	3291	3761	4231	4701
1 3/4	109	218	327	437	546	655	873	1091	1310	1528	1746	1964	2183	2619	3056	3492	3929	4365
1 7/8	102	204	306	407	509	611	815	1019	1222	1426	1630	1833	2037	2445	2852	3259	3667	4074
2	95	191	286	382	477	573	764	955	1146	1337	1528	1719	1910	2292	2674	3056	3438	3820
2 1/4	85	170	255	340	424	509	679	849	1019	1188	1358	1528	1698	2037	2377	2716	3056	3395
2 1/2	76	153	229	306	382	458	611	764	917	1070	1222	1375	1528	1833	2139	2445	2750	3056
2 3/4	69	139	208	278	347	417	556	694	833	972	1111	1250	1389	1667	1945	2222	2500	2778
3	64	127	191	255	318	382	509	637	764	891	1019	1146	1273	1528	1783	2037	2292	2546

Revolutions per minute for other cutting speeds than given in the table can be determined by adjusting values in the different columns. For instance, to determine the revolutions required for a surface speed of 90 feet per minute, take 1/10 of figures for a given diameter in the 900 foot column.

# APPENDIX B

**Table 17: Typical Hardness of Copper Beryllium Rod, Bar, Plate, Tube and Wire**

Form	Alloy	Temper	Heat Treatment <sup>2</sup>	Size: Diameter or Distance Between Parallel Surfaces (in.)	Rockwell Hardness
Rod, Bar, Plate, Tube	25, M25	A		ALL SIZES	B45-85
		H		UPTO 3/8	B92-103
				3/8 TO 1	B91-102
				OVER 1	B88-101
		AT	3 HRS. at 625±25°F	ALL SIZES	C36-40
		HT	2-3 HRS. at 600±25°F	UPTO 3/8	C39-45
	3/8 TO 1			C38-44	
	OVER 1			C37-43	
	165	A		ALL SIZES	B45-85
		H		UPTO 3/8	B92-103
				3/8 TO 1	B91-102
				OVER 1	B88-101
		AT	3 HRS. at 625±25°F	ALL SIZES	C32-39
		HT	2-3 HRS. at 600±25°F	UPTO 3/8	C36-41
	3/8 TO 1			C35-40	
	OVER 1			C34-39	
3 & 10	A		ALL SIZES	B20-50	
	H			B60-80	
	AT	3 HRS. at 900±25°F		B92-100	
	HT	2 HRS. at 900±25°F		B95-102	
Wire <sup>1</sup>	25 & M25	A		ALL SIZES	B45-85
		H		UPTO 0.080	B92-103
				0.080 TO 3/8	B88-101
				OVER 3/8	B88-101
		AT	3 HRS. at 625±25°F	ALL SIZES	C36-41
		HT	1 HR. at 600±25°F	UPTO 0.080	C39-46
				1 1/2 - 3 HRS. at 600±25°F	0.080 TO 3/8
		OVER 3/8	C37-43		
Forged Products	25	A		ALL SIZES	B45-85
		AT	3 HRS. at 625±25°F		C36-41
	165	A			B45-85
		AT	3 HRS. at 625±25°F		C32-39
	3 & 10	A			B20-50
		AT	3 HRS. at 900±25°F		B92-100

<sup>1</sup> Except rectangular other than square.

<sup>2</sup> Properties and appropriate heat treating time are a function of chemical composition, amount of cold work, product form and product size. Ask Brush Performance Alloys for information about specific products.

NOTE: The hardness data in this table are for machining guidance only and do not fully distinguish hardness differences (usually minor) among the various product forms. The user is advised to consult the ASTM or other specification applicable to the product form (plate, strip, rod, tube, wire, etc) for specific hardness information.

**Table 18: Typical Hardness of Copper Beryllium Castings**

Alloy	Temper	Rockwell Hardness
<b>275C</b>	C	B80-90
	CT	C20-25
	A	B80-95
	AT	C43-47
<b>245C</b>	C	B81-86
	CT	B20-25
	A	B70-76
	AT	C40-45
<b>20C</b>	C	B80-85
	CT	C20-24
	A	B65-75
	AT	C38-43
<b>21C</b>	C	B74-82
	CT	C20-24
	A	B46-54
	AT	C34-39
<b>10C</b>	C	B50-60
	CT	B65-75
	A	B35-45
	AT	B92-100
<b>3C</b>	C	B55-65
	CT	B75-90
	A	B35-45
	AT	B92-100

NOTE: Properties are typical of precision cast material, while properties of sand castings tend to be closer to the low end of the ranges shown. Additional information regarding the properties, characteristics and heat treating of the casting alloys is available in the Brush Performance Alloys publication, Copper Beryllium Casting and Master Alloys.

# SCRAP GENERATED FROM MACHINING

The machining scrap from copper beryllium alloys can be a valuable resource. Brush Performance Alloys purchases copper beryllium scrap at a premium price if the scrap is segregated by alloy type and is free of contamination by other metals.

**Contact Brush Performance Alloys for our scrap policies and procedures at 1-800-Buy-BeCu.**



**Health & Safety** – Handling copper beryllium in solid form poses no special health risk. Like many industrial materials, beryllium-containing materials may pose a health risk if recommended safe handling practices are not followed. Inhalation of airborne beryllium may cause a serious lung disorder in susceptible individuals. The Occupational Safety and Health Administration (OSHA) has set mandatory limits on occupational respiratory exposures. Read and follow the guidance in the Material Safety Data Sheet (MSDS) before working with this material. For additional information on safe handling practices or technical data on copper beryllium, contact **Materion Brush Performance Alloys, Technical Service Department** at 800.375.4205.

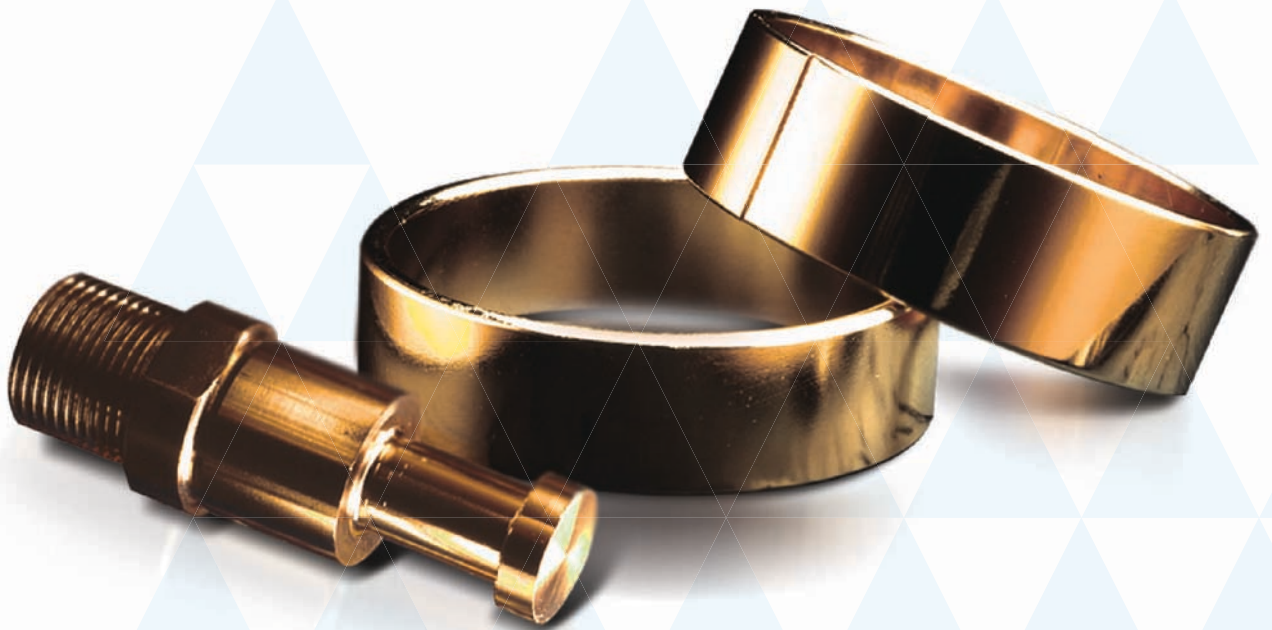

# Brush Performance Alloys



# MATERION

## ABOUT MATERION

Materion is the new name for Brush Engineered Materials Inc., its Brush Wellman Inc. subsidiary, and all of the company's businesses worldwide. Materion is among the world's premier providers of advanced materials solutions and services. Now under the one Materion brand, we are better aligned to deliver a broader scope of products, services and expertise needed to drive our customers' growth and profitability and become their first choice in a partner. Materion Corporation common stock trades on the New York Stock Exchange under the symbol MTRN.

## MATERION BUSINESSES

Advanced Chemicals  
Barr Precision Optics & Thin Film Coatings  
Brush Beryllium & Composites  
Brush Performance Alloys  
Ceramics  
Electrofusion  
Large Area Coatings  
Microelectronics & Services  
Natural Resources  
Technical Materials

## BRUSH PERFORMANCE ALLOYS INTERNATIONAL LOCATIONS

CHINA/HONG KONG  
p + 852.2318.1907  
brushalloysHK-info@materion.com

CHINA/SHANGHAI  
p + 86.21.5237.2328  
brushalloysCN-info@materion.com

GERMANY  
p + 49.711.830.930  
brushalloysDE-info@materion.com

INDIA/PUNE  
p + 91.99606.33744  
brushalloysIN-info@materion.com

JAPAN  
p + 81.33.230.2961  
brushalloysJP-info@materion.com

REPUBLIC OF KOREA  
p + 82.32.811.2171  
brushalloysKR-info@materion.com

SINGAPORE/ASEAN  
p + 65.6842.4456  
brushalloysSG-info@materion.com

TAIWAN, R.O.C.  
p + 886.2.2747.8800 ext. 121  
brushalloysTW-info@materion.com

UNITED KINGDOM & IRELAND  
p + 44.118.930.3733  
brushalloysUK-info@materion.com

## BRUSH PERFORMANCE ALLOYS

Main Office  
6070 Parkland Boulevard  
Mayfield Heights, OH 44124 USA  
p 800.375.4205 +1.216.486.4200  
[www.materion.com/brushalloys](http://www.materion.com/brushalloys)